

**SHENZHEN ATTEN TECHNOLOGY CO., LTD.**

---

- Soldering Iron ●Soldering Station ●Hot Air Rework Station
- Multi-function Rework System ●BGA Rework System
- Regulated DC Power Supply ●Switching DC Power Supply
- Programmable Power Supply

# ATTEN

## AT8502D

# SOLDERING STATION SMD REWEEK **2 in 1**

**THERMO-CONTROL ANTI-STATIC**

**Intelligent lead-free rework station**

**User's Manual**

---

**SHENZHEN ATTEN TECHNOLOGY CO., LTD.**

Add: Floor 8, Building 2, Senyang High-tech Park, 7 West Road  
High-tech Park, Guangming New district, Shenzhen 518132, China

Tel: +86-755-2697 6387

Fax: +86-755-8602 1337

Web: [www.atten.com.cn](http://www.atten.com.cn)(CN)

[www.atten.com](http://www.atten.com)(EN)

Email: [sales@atten.com.cn](mailto:sales@atten.com.cn)

**THE NO.1**  
INSTRUMENTS BRAND IN CHINA  
All Copyright Reserved  
MADE IN CHINA  
CBN020794 (E)

SHENZHEN ATTEN TECHNOLOGY CO.,LTD.



QFP	SOP	PLCC	A1124	A1125	A1126	A1127	A1128
A1129 PLCC 20×20(0.78×0.78) QFP 28×28(1.1×1.1)	A1130 SOP 44×10(0.17×0.38)	A1131 SOP 44×10(0.17×0.38)	A1124 φ2.5 (φ0.6)	A1125 QFP 10×10(0.38×0.38)	A1126 QFP 14×14(0.55×0.55)	A1127 QFP 17.5×17.5(0.68×0.68)	A1128 QFP 14×20(0.55×0.78)
A1136 PLCC 20×20(0.78×0.78)	A1137 PLCC 25×25(0.98×0.98)	A1138 PLCC 30×30(1.18×1.18)	A1139 PLCC 12.5×7.3(0.49×0.29)	A1140 PLCC 11.5×11.5(0.45×0.45)	A1141 PLCC 11.5×14(0.45×0.55)	A1142 Bent Single 15×3(0.06×0.12)	A1135 PLCC 17.5×17.5(0.68×0.68)
A1261 QFP 20×20(0.78×0.78)	A1262 QFP 12×12(0.47×0.47)	A1263 QFP 28×40(1.1×1.57)	A1264 QFP 40×40(1.57×1.57)	A1265 QFP 32×32(1.26×1.26)	A1266 BOFP 24×24(0.94×0.94)	A1257 SOP 1×21(0.43×0.8)	A1258 SOP 7.6×12.7(0.3×0.5)
A1259 SOP 13×28(0.51×1.1)	A1260 SOP 6×18(0.34×0.71)	A1267 TSOL(TSOP) 8.5×8(0.73×0.31)	A1268 SOP 6×18(0.34×0.71)	A1269 SOP 13×28(0.51×1.1)	A1270 SOP 13×28(0.51×1.1)	A1271 SOP 13×28(0.51×1.1)	A1272 SOP 13×28(0.51×1.1)

AT8502 is an intelligent lead-free rework station, which combines rework station and soldering station. It is especially suitable for R&D, production, lab of scientific research and so on. It is easy to operate, user-friendly and greatly space-saving.

In order to keep machine from damage and insure the safety of operation, please read through the manual and keep it for required.

## Safety and Caution:

### Caution

The temperature of the hot-air nozzle is 400°C so it may lead to injury, fire and other accident because of improper usage. Please abide the following terms:

1. Don't make the rework station be against people or animals. And never use it as a hair drier and touch the heating element or blow the skin directly.
2. Never operate it near the flammable gas or substance and put it beside them after use.
3. After use, the power should be off and it will be automatically off when the hot air temperature is lowered, (There is fuse inside, so great attention must be paid to superheat in case of accident.)
4. Please care for using hot-air gun, never make it fall or shake heavily and put the heavy things on it or press the buttons improperly.
5. Don't operate with wet hands or wet wire in order not to result in short circuit or electronic shock.
6. Keep away from children.
7. Please use the nozzle offered by manufacture and don't replace the original nozzle.
8. Temperature will vary from the models of the nozzles, which is normal.
9. Don't touch the iron tip or surrounding metals.
10. Change the components or tip after cutting off power and waiting to cool it.
11. Don't use this device do other work except soldering.
12. Don't rap the handle to remove the doss of tip, which is bad for it.
13. Don't pull the cable but hold tightly the plug when you take out of plug.
14. Please keep good ventilation because there is smoke when solder.
15. Don't play with other people or would be easy to hurt others or yourself.
16. Please pay attention to the specifications of the power supply, for manufacture offer different specifications, so be careful of selection.

## Characteristics:

1. Two-in-one design for the welding station and hot wind unsoldering station saves space.
2. Double-window LED screen display , visualized operation and simple and easy to operate.
3. The diaphragm type air pump with large pressure can work with many types of spray nozzles.
4. The intelligent cooling system and the extension of air feeding time after shutdown protects the hot wind handgrip much more efficiently.
5. Digital temperature correction, immediate keying design for the handgrip, and easy to use.
6. The patented auger-type heating core built in the hot wind welding station results in quick temperature rise and much more prolonged service life.
7. Three sets of independent memory functions, and quick switch of the integrated mode of amount of wind at different temperatures.
8. Dormant function economizes on the energy.

## Machine diagram:



## Interchangeable soldering tips of soldering station

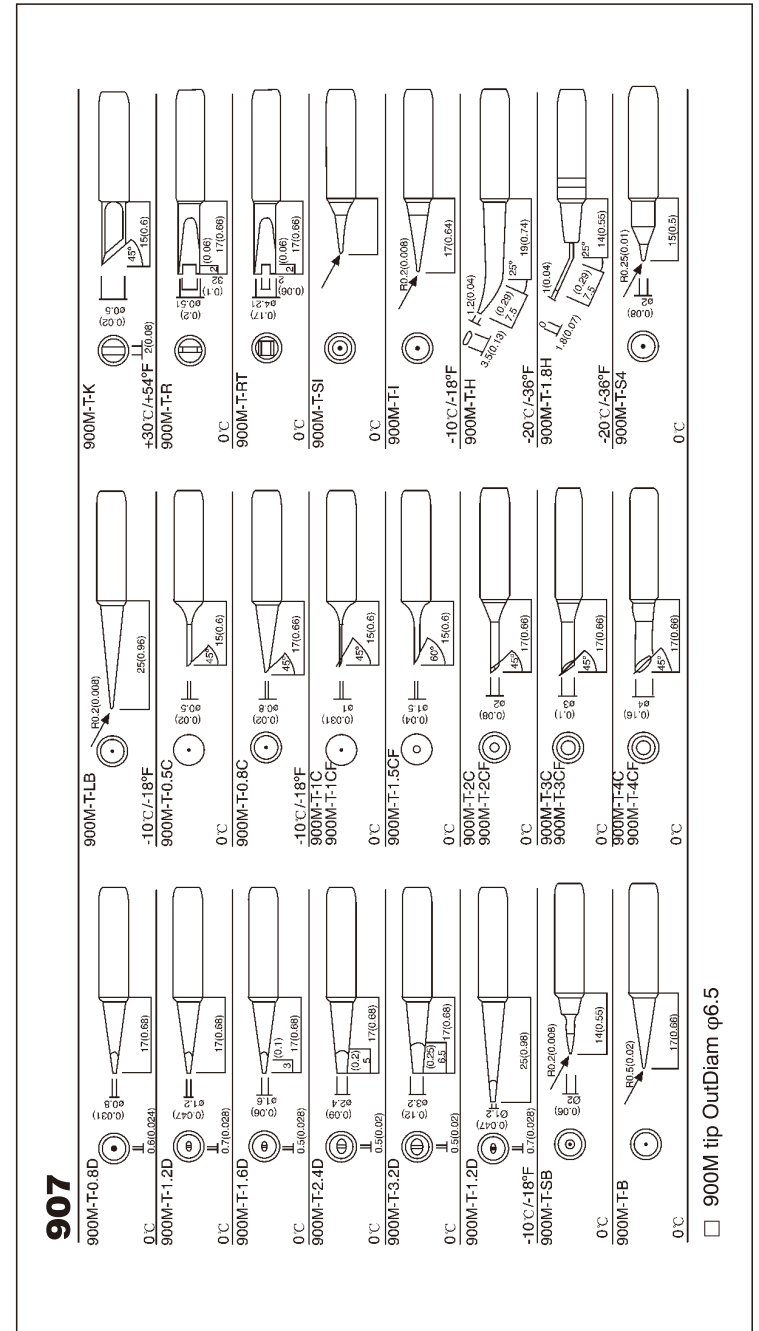

## List of accessories:

AT8502D	1 unit
Power cord	1 strip
Nozzle	1 set
Bracket	1 set
907 handle	1 pc
905 iron holder	1 set
User manual	1 copy



**WARNING:** This tool be placed on its stand when not in use. The instructions for heat guns and hand-held paint strippers shall include the substance of following:

A fire may result if the appliance is not used with care, therefore be careful when using the appliance in places where there are combustible materials:

- Do not apply to the same place for a long time;
- Do not use in presence of an explosive atmosphere;
- Be aware that heat may be conducted to combustible materials that are out of sight ;
- Place the appliance on its stand after use and allow it to cool down before storage;
- Do not leave the appliance unattended when it is switched on;

## Technical Specifications:

Model	AT8502D	Intelligent lead-free rework station
Total power	About 700W (max)	Heating: 550W(max), pump(diaphragm): 40W Soldering Station: 60W
Range for temperature controlling	Hot Air Rework Station	100-500°C
	Soldering Station	200-480°C
Temperature unit	°C/°F	Convertible
Temperature controlling stability	Static	2°C
Temperature controlling accuracy	Static	10°C
	Celsius	50°C ~ -50°C
Calibration range	Fahrenheit	-58°F ~ 122°F
	Rework Station (in the factory)	1: 200°C, 40; 2: 300°C, 60; 3: 400°C, 80
Setting storage (3 groups)	Soldering Station (in the factory)	1: 200°C; 2: 300°C; 3: 400°C
	Rework Station	020—100 level
Dormancy and standby	Rework Station	Stopping heating, air-blowing delay and then be in the condition of dormancy and standby.
Cold Air	Rework Station	Air-blowing made by the machine and stopping heating.
Malfunction alert	Heating elements	Displaying H-E
	Sensor	Displaying S-E
Shutdown	Shutdown in the normal condition	Cold air delay shutdown, power off

## Function diagram:

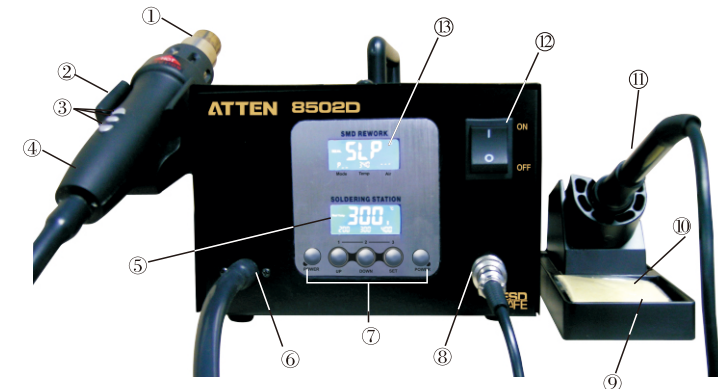

- |   |                               |
|---|-------------------------------|
| ① Rework station nozzle                                     | ② Hot-air handle bracket      |
| ③ Hot-air handle button group                               | ④ Rework station handle       |
| ⑤ B screen to display working station of soldering stations | ⑥ Output of hot-air           |
| ⑦ Function button groups                                    | ⑧ Output of soldering station |
| ⑨ Iron holder   | ⑩ Sponge for clean iron       |
| ⑪ Iron handle   | ⑫ power switch                |
| ⑬ A screen to display working station of soldering stations |                               |

## Button instructions:

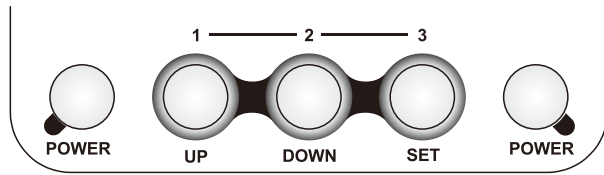

Position	Knob/Button	First function	Second function (short press < 5s)	Second function (long press > 5s)
<b>Front Panel Buttons</b>	POWER	Work and shutdown of the rework station	Group	Group
	<b>UP</b>	Value increasing	Press with  knob and then select hot-air quick key 1 to set.	Press with  knob and deposit the setting of hot-air quick knob 1
	<b>DOWN</b>	Value decreasing	Press with  knob and then select hot-air quick key 2 to set.	Press with  knob and deposit the setting of hot-air quick knob 2
			Press with  knob and then select soldering station quick key 1 to set.	Press with  knob and deposit the setting of iron quick knob 1
	<b>SET</b>	Set temperature and confirmation varies of settings	Press with  knob and then select hot-air quick key 3 to set.	Press with  knob and deposit the setting of hot-air quick knob 3
			Press with  knob and then select soldering station quick key 2 to set.	Press with  knob and deposit the setting of iron quick knob 2
POWER	Work and shutdown of soldering station	Group	Group	
<b>Hot-air station handle knob</b>	<b>UP</b>	To increase the Set value of hot-air station		
	<b>DOWN</b>	To decrease the Set value of hot-air station		
	⊗	Adjustment of air volume	Blowing cold air of rework station	Awake hot air of rework station

- E. Insert new heating element in PCB board, pay attention to install properly.  
 F. Install it as the contrary method of remove.

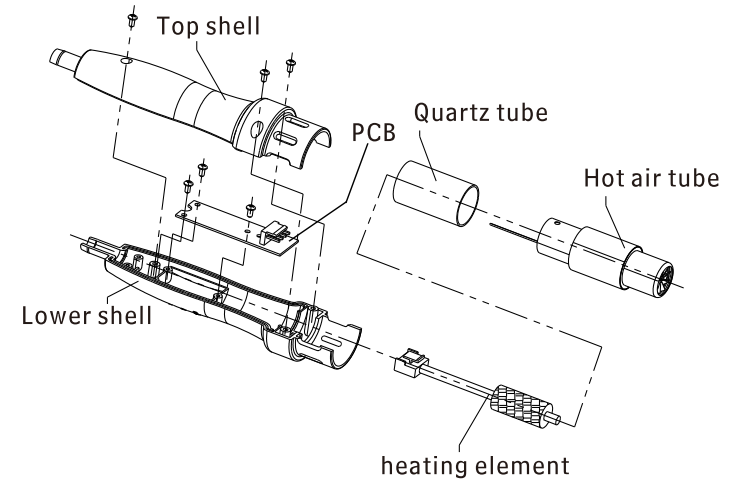

Please follow the following steps for the successful replacement of heating element of soldering station:

- Cut down power; replace the heating element after it is cool.
- As following diagram, unscrew the nut ①, take out the stainless steel cap ② and iron tip ③, then unscrew the fixed holder ④, desoldering the heating element ⑤.
- Replace the good condition heating element and install it as the contrary method of remove.

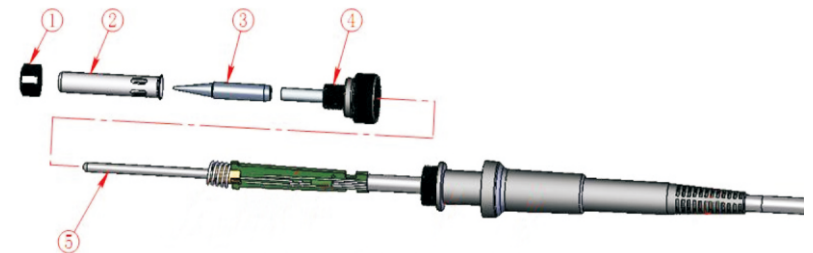

## 5. Standby

In normal working condition, press POWER key at the right of panel to make the device be standby (diagram 2). Make the power off, at the same time, the soldering station is off and the whole station will off when the temperature is low to 100°C.

Standby state of screen B



(diagram 2)

## 6. Error/Fault indication

- When "H-E" is displayed on the screen A, there is no temperature (diagram 19), which indicates that the heating element fails.
- When "S-E" is displayed on the screen A, there is a fault in sensor (diagram 20), which signifies that there is something wrong with the sensor or the related circuit of the sensor.

Screen B: fault of heating



(diagram 19)

screen B: fault of sensor



(diagram 20)

## III. Conversion of temperature unit

Under the power off condition, hold down the UP, DOWN and SET knob and then put power on to switch °C/°F.

## IV. Replacement of heater

Please follow the following steps for the successful replacement of the heating element of hot-air rework station:

- Cut down power, please refer to the following diagram to replace heater after it is cool.
- Based on diagram, loosen the three screws of the handle.
- Dismantle the upper cover of the handle, pull out the ground wire on the duct and take out the fan.
- Take out the heating element from PCB board.

## Installation:

The brackets for the handles must be installed when operating for the first time.

Please see the following illustration:

- Please fix the bracket by tightening the four screws according to the illustration and your personal habit.
- According to your selection, dismantle the two screws on the left or the right, which fix the bracket of the handle.
- Place the two installation hole of the bracket to the two fixed screw holes of the machine, and then tighten the dismantled two screws. Put the components of the handle on the bracket to check if it is suitable.

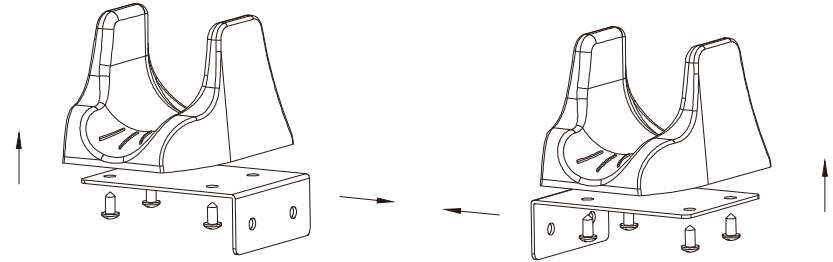

## Introduction for LCD display:

A screen (rework station, same as below)

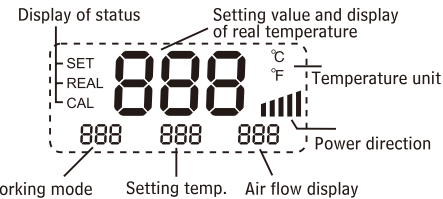

B screen (soldering station, same as below)

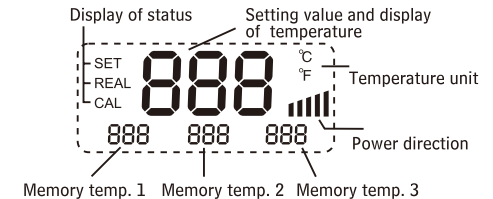

## Description for LCD display

- Display "--" means the device is standby
- Screen "A" displays the working state of rework station.
- "P\_" means rework station is under the normal setting condition.
- "P 0 1" means rework station is under the condition set by memory group 1.
- "P 0 2" means rework station is under the condition set by memory group 2.
- "P 0 3" means rework station is under the condition set by memory group 3.
- Both screen A and screen B display "OFF" in the memory temperature area 2, which means the device, is standby.
- When the temperature area shines °C/°F the station is under the condition available to set.

## Power:

Upon power on the unit, the reworking station and soldering station be standby.

Standby state of screen A



(diagram 1)

Standby state of screen B



(diagram 2)

## I . REWORK STATION

1. Power on: Rework station start to work after press the "POWER" knob at the left of panel.

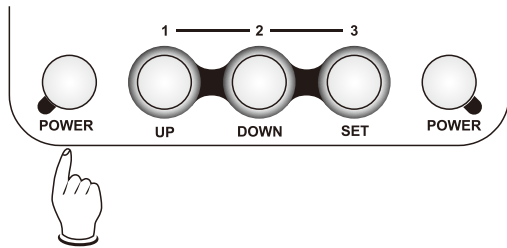

2. At that time, if the handle is on the bracket, screen "A" display state standby (diagram 3), or display the setting temperature and 3 seconds later it display the actual temperature (diagram 4, diagram 5).

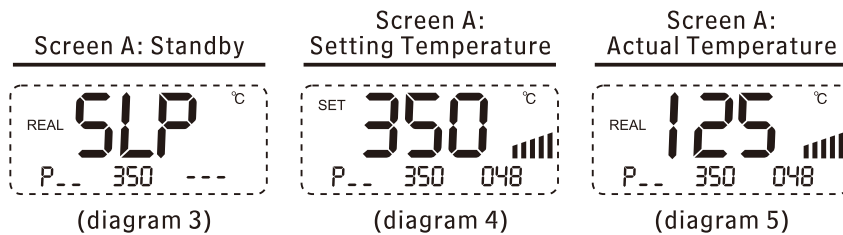

3. Temperature Settings

In normal condition, there are two methods to set temperature of hot-air reworking station.

- A. If screen A shines °C/°F setting temperature through operating the button of panel. If screen A doesn't shine °C/°F you must press the "SET" button to switch to shine °C/°F of screen A then the station

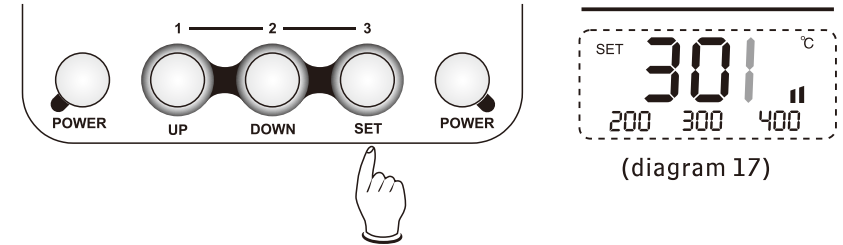

(diagram 17)

## 3.Shortcut keys set storage

Under normal working condition, hold down POWER knob at the left of panel, at the same time long press (>5s) the UP knob or DOWN or SET to adjust temperature to the required values separately in term1 or term2 or term3. When you hold down POWER knob at the left of panel and short press (<5s) UP or DOWN or SET knob to use the storage setting temperature into current work temperature and air volume.

**(Notice: up, down, set refer to storage term1, term2, term3)**

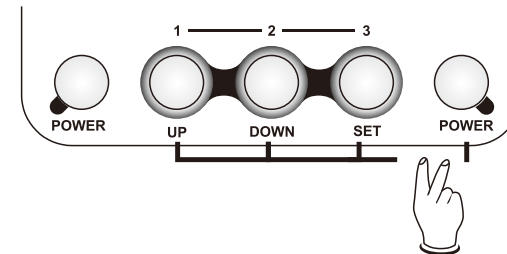

## 4.Temperature comp temperature and calibration

Under normal working condition, hold down both POWER knob at right of panel and "※" knob on the handle to calibrate soldering station temperature (diagram18). Temperature value can be calibrated by pressing UP or DOWN knobs. Pressing the SET knob to confirm storage and quit from this calibration (diagram 11).



(diagram 18)



## 10. Error/Fault indication

1. When "H-E" is displayed on the screen A, there is no hot air in the nozzle (diagram13), which indicates that the heating element fails.
2. When "S-E" is displayed on the screen A, there is a fault in sensor (diagram14), which signifies that there is something wrong with the sensor or the related circuit of the sensor.

Screen A: no hot-air fault



(diagram 13)

Screen A: sensor fault

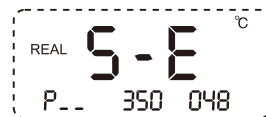

(diagram 14)

## II. SOLDERING STATION

### 1. Power on

Screen B which displays actual temperature in 3s displays setting temperature after pressing POWER knob at the right of panel (diagram15, diagram16).

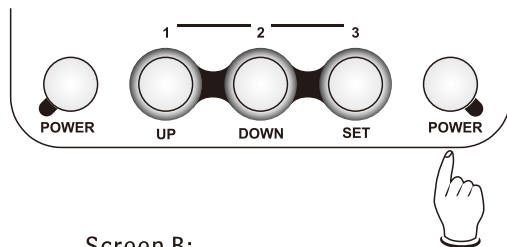

Screen B:  
Temperature Settings



(diagram 15)

Screen B: heating



(diagram 16)

### 2. Temperature setting

In normal working condition, if screen B shines °C/°F or you at first continually press SET knob twice to switch to shine °C/°F, then press the UP or DOWN knob to adjust temperature. Screen B shines "SET" and the main temperature area shines the setting temperature of soldering station. Stopping pressing knob or pressing SET knob confirm and keep settings and quit from this operation (diagram17).

Under the setting condition. Then you can press "SET" button to set hot-air rework station's temperature and the main temperature area shines the setting temperature, you can press UP knob or DOWN knob to adjust the setting temperature. 4s-no-press or press SET knob, you can keep the temperature and quit out this setting. (Diagram 6).

- A. Setting temperature via handle of rework station. You can press UP knob or DOWN knob directly to adjust temperature and the main temperature area indicators setting temperature. 4s-no-press or press SET knob, you can keep the temperature and quit out this setting, at that time, you can adjust hot-air volume by pressing "※" Whether screen A or screen B shine °C/°F as you set, the device is under the setting condition and shining area for °C/°F switch to screen "A" automatically.

**Notice:** continually pressing UP or DOWN knob in long time will quickly adjust the temperature, at that time, the screen don't shine. (Same as below description)

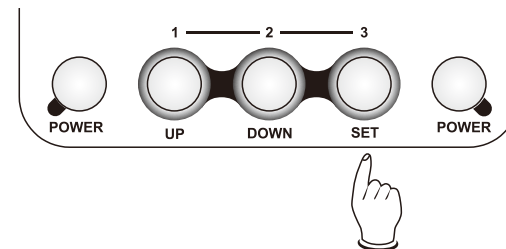

(diagram 6)

### 4. Hot-air volume settings

In normal working condition, there are two methods to set hot-air volume:

- A. If screen A shines °C/°F setting temperature through operating the button of panel. If screen A doesn't shine °C/°F you must press the "SET" button to switch to shine °C/°F of screen A then the station under the setting condition. Then you can press "SET" button to set hot-air rework station's temperature and the main temperature area shines the setting temperature, you can press UP knob or DOWN knob to adjust the setting temperature. 4s-no-press or press SET knob, you can keep the temperature and quit out this setting (diagram 7).
- B. Setting hot-air volume via handle of rework station. You can press UP knob or DOWN knob to adjust hot-air volume and the main temperature area indicators setting volume. 4s-no-press or press SET knob, you can keep the volume and quit out this setting, at that time, you can adjust hot-air volume by pressing "※" When the screen A or screen B shine °C/°F as you set, the device is under the setting condition and shining area for °C/°F switch to screen "A" automatically.

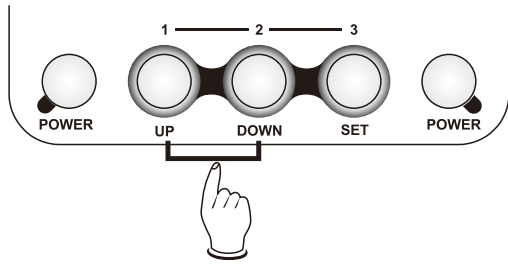

(diagram 7)

## 5. Storing the Temperature values

Under normal working condition, hold down POWER knob at the left of panel, at the same time long press (>5s) the UP knob or DOWN or SET to adjust temperature and air volume to the required values separately in term 1 or term 2 or term 3. But when you hold down POWER knob at the left of panel and short press (<5s) UP or DOWN or SET knob to use the storage setting temperature and air volume into current work temperature and air volume (diagram8, diagram9, diagram10).

(Notice: up, down, set refer to storage term 1, term 2, term 3)

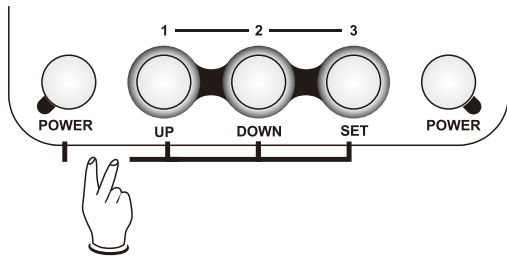

Screen A:  
Working state of shortcut 1



(diagram 8)

Screen A:  
Working state of shortcut 2



(diagram 9)

Screen A:  
Working state of shortcut 3



(diagram 10)

## 6. Temperature comp temperature and calibration

Under normal working condition, hold down both POWER knob at left of panel and "※" knob on the handle to calibrate. Screen A will display the character CAL, and temperature value can be calibrated by pressing UP or DOWN knobs. Pressing the SET knob to confirm storage and quit from this calibration (diagram 11).



(diagram 11)

## 7. Dormancy

Under normal working condition, when the user put the handle on the bracket, then the equipment will be automatically switch to the dormancy condition and the heater also stops heating. This happens in the case when the temperature is higher than 100°C, during the hot-air station dormancy period the screen A display character SLP (diagram 3)

Screen A: Standby



(diagram 3)

## 8. Conversation between cold-air and hot-air

In normal condition, continually press "※" knob twice and then make the hot-air be in the state of cold-air blow (diagram12). Under the cold-air condition, press "※" knob once, recover the hot-air working condition.

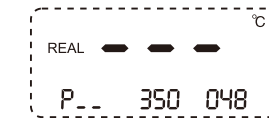

(diagram 12)

## 9. Standby

Under normal working condition, the device keep the current temperature and air volume and cut down heating to the rework station after pressing POWER knob at the left of panel (diagram 1A), below 100°C, the device is standby (diagram1). If power is off, the soldering station is off, whole device will be off after the temperature below 100°C.



(diagram 1A)

Standby state of screen A

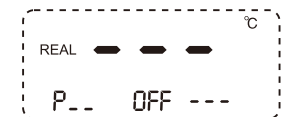

(diagram 1)